

Installation Instructions for Crystal Union & Crystal Veil Chandeliers

IMPORTANT INFORMATION

- This product is UL listed for indoor dry locations.
- This product is ceiling mounted only.
- This product can mount to either a 4" square electrical box with round plaster ring or an octagon electrical box.
- This product can be dimmed with a standard incandescent dimmer.

SAVE THESE INSTRUCTIONS!

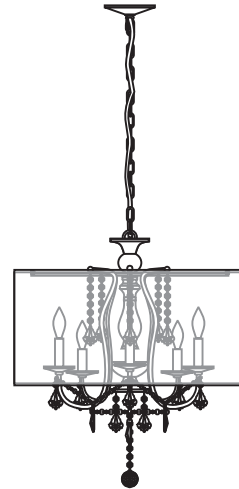

Install the Crystals

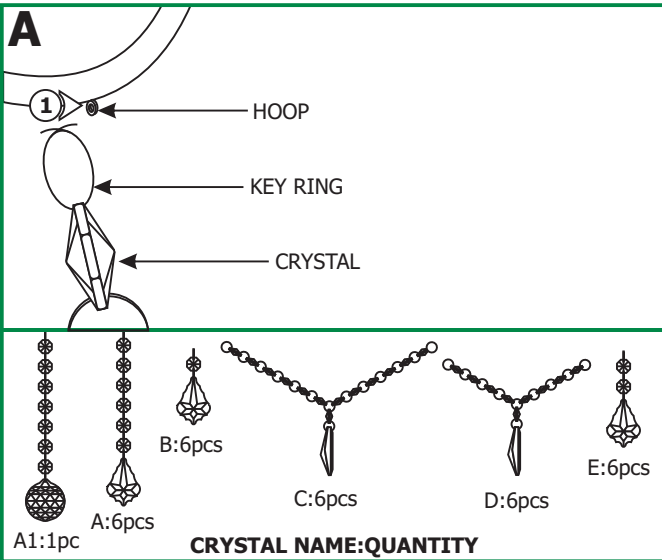

NOTE: It is recommended to hang the crystals before installing the chandelier. Follow step 1 to install all crystals. Follow steps 2 through 7 to install the crystals in correct position and orientation.

- 1:** To install a crystal, squeeze the key ring to open the end. Slide the end through the designated hoop and rotate it inside the hoop to lock in place.

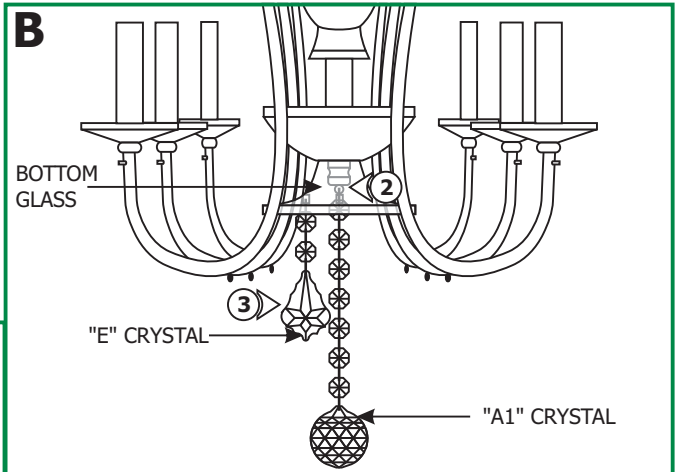

- 2:** Install the single crystal marked "A1" into the hoop located in the center of the bottom glass.

- 3:** Install the six pieces of crystals marked "E" into the hoops located around the perimeter of the bottom glass.

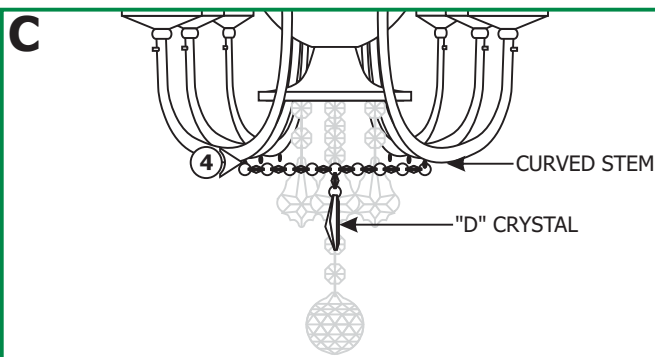

- 4:** Install the six pieces of crystal marked "D" into the hoops located on the bottom of each curved socket stem, so that one end is hooked into one socket stem hoop and the other end into the adjacent socket stem hoop. Each curved socket stem will hold two crystal key rings when all crystals are installed.

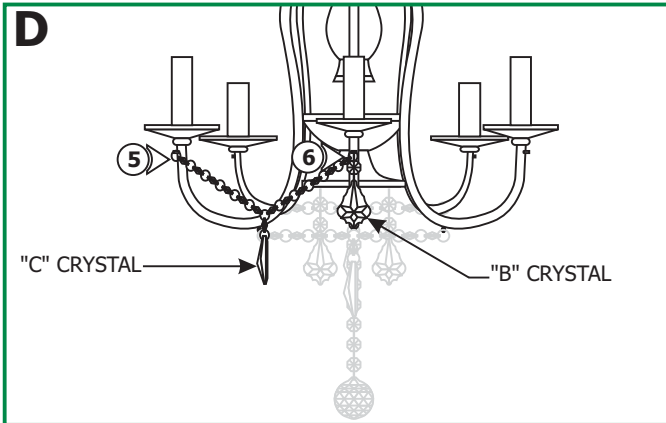

5: Install the six pieces of crystals marked "C" into the hoops located under each socket assembly so that one end is hooked into one socket assembly hoop and the other end into the adjacent socket assembly hoop.

6: Install the six pieces of crystal marked "B" into each socket assembly hoop. Each socket assembly hoop will hold three key rings when all crystals are attached (one "B" and two "C" crystals).

7: Install the six pieces of crystal marked "A" into each hoop at the top end of the curved stems.

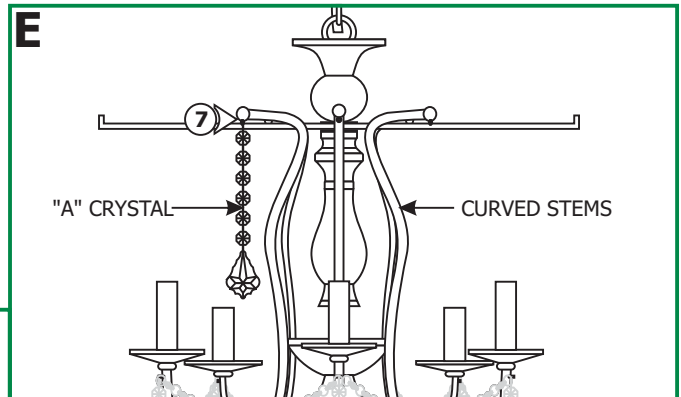

Install the Fixture

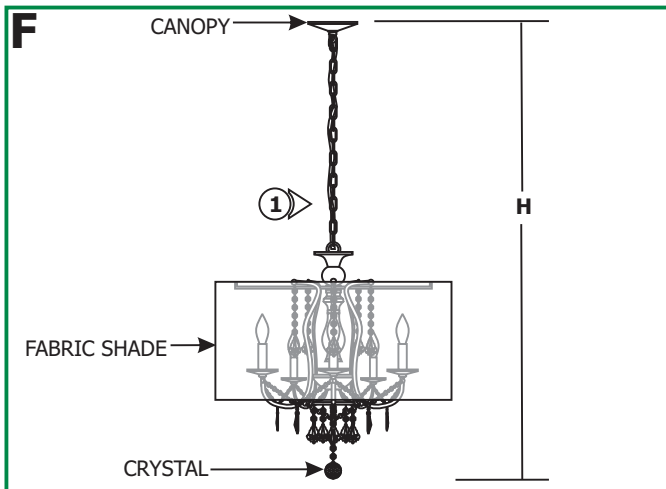

1: Determine the desired fixture height (**H**), from the bottom of the crystals to the top of the canopy.

2: Loosen the nut on the adjustable link and remove it from the hook bushing.

3: If not adjusting the fixture height, then omit steps 4 through 6.

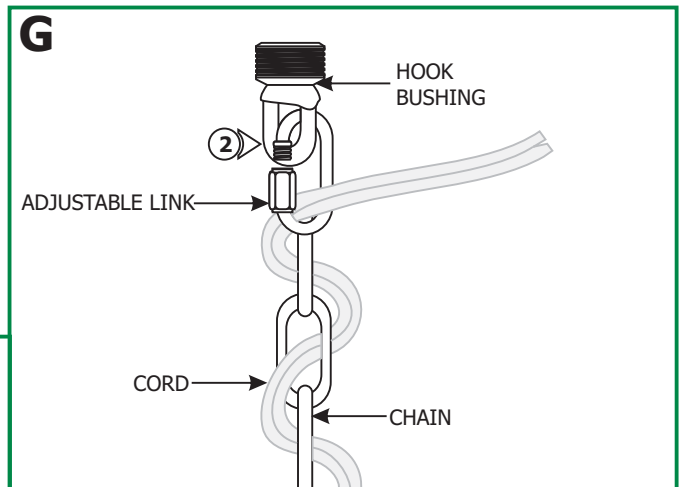

4: Remove the adjustable link from end of the chain.

5: Use two pairs of pliers to open the link closest to desired height. Remove the excess links from the chain. Make sure to consider the adjustable link as part of the fixture height.

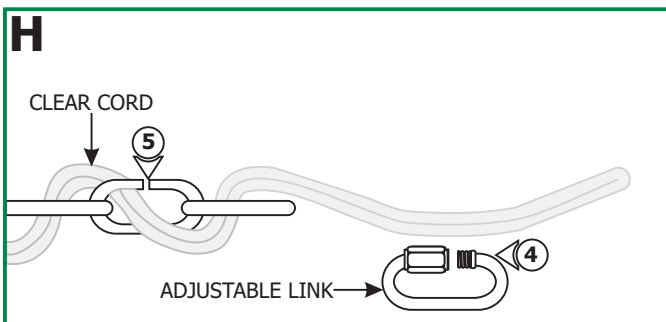

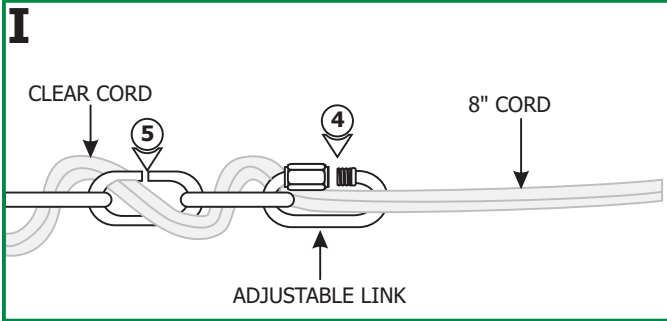

6: Replace the adjustable link to the end of the chain.

7: Run the fixture cord zigzag through the links. Trim end of the cord leaving 8" behind the adjustable link for power connection.

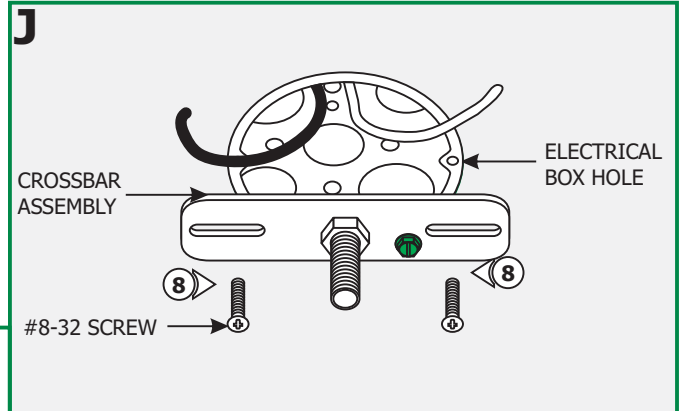

8: Mount the crossbar assembly to the electrical box holes with the two provided #8-32 screws

9: Tighten the hook bushing completely to the crossbar assembly nipple.

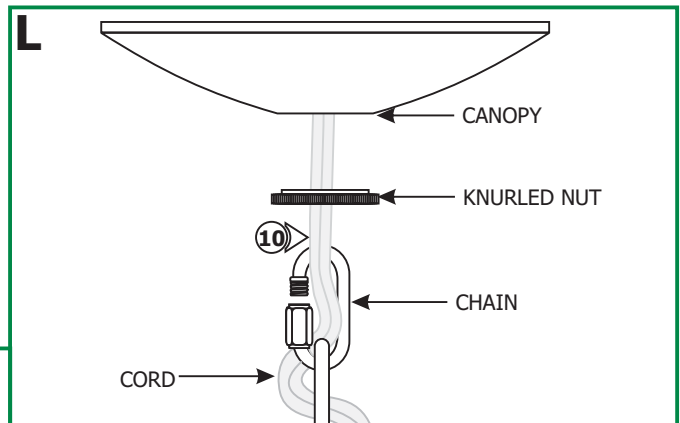
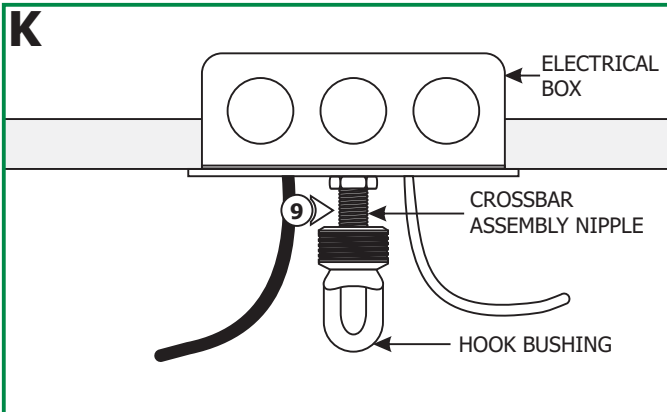

10: Feed the cord through the flat section of the knurled nut (lip facing up) and the canopy hole.

11: Feed the cord through the hook bushing into the electrical box.

12: Hook the adjustable link into the hook bushing and tighten the nut to secure it in place.

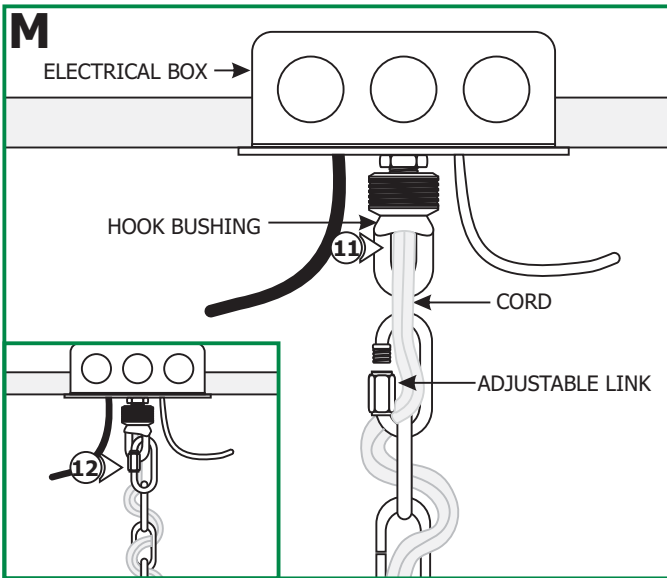

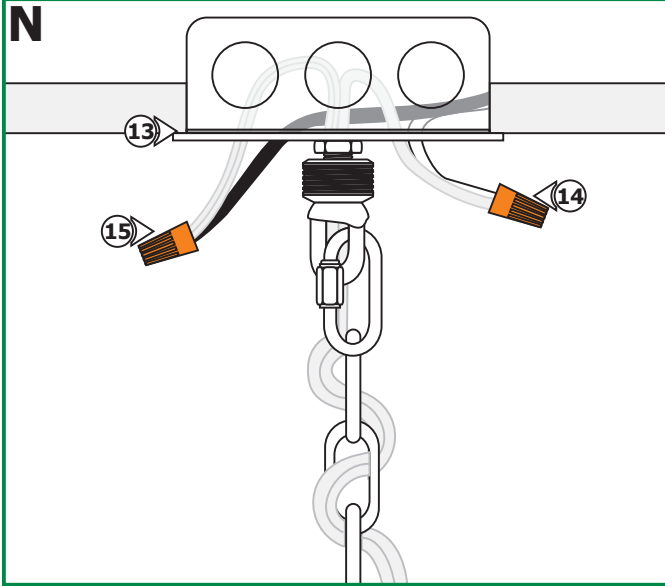

13: Make sure that the crossbar assembly is grounded in accordance with local electrical codes.

14: Connect the smooth edge wire of the cord to the hot power wire with a wire nut.

15: Connect the rough edge wire of the cord to the neutral power wire with a wire nut.

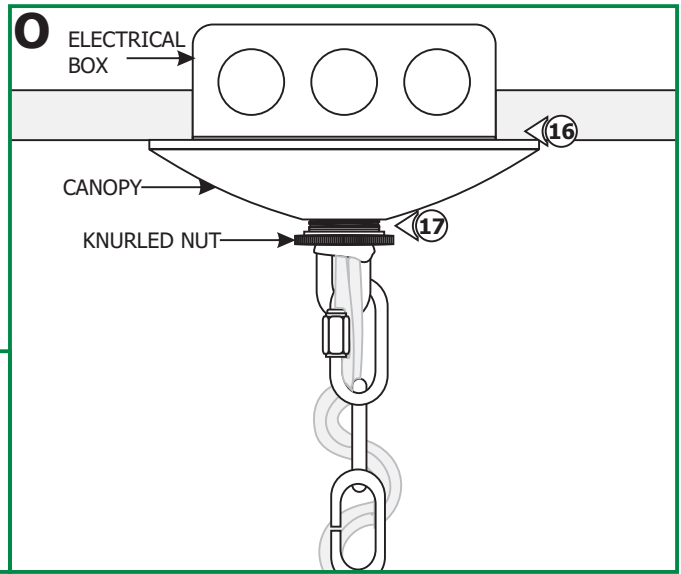

16: Place all wires and wire nut connections inside electrical box.

17: Slide the canopy up against the electrical box. Tighten the knurled nut to the hook bushing threads. If necessary loosen the hook bushing a little bit so that the knurled nut can reach the hook bushing threads.

Install the Lamp & Shade

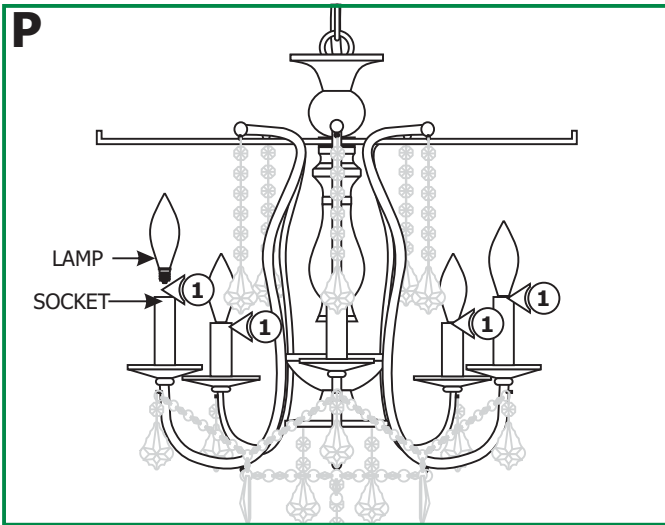

CAUTION: To reduce risk of a burn or electrical shock during lamping, disconnect the power to the fixture.

Use **MAX 60** Watt Type E12 base, Torpedo Style Candelabra Base Lamp For Each Socket.



1: Screw each lamp completely into one socket.

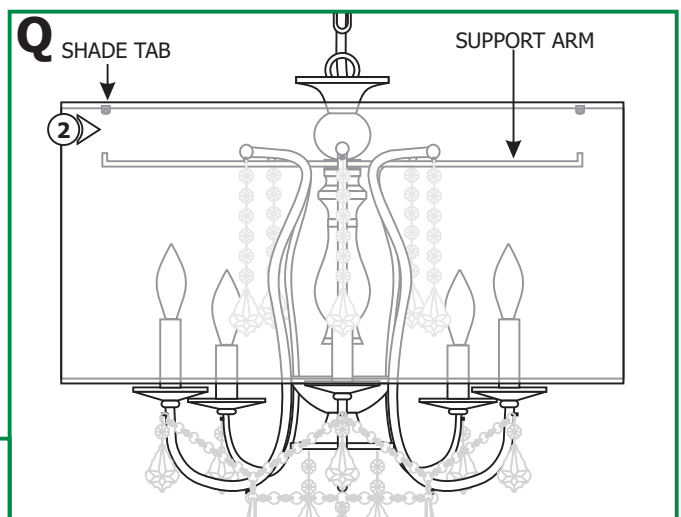

2: Slide the fabric shade from the bottom of the chandelier up. Align and set the shade tab holes onto the support arm ends.