

Installation Instructions for Taos Square

IMPORTANT INFORMATION

- This product is for indoor and outdoor locations.
- **RISK OF FIRE:** This product must be installed 4 ft above the ground for wet locations.
- This product is for wall mount applications only.
- This product can mount to either a 4" square electrical box with round plaster ring or an octagon electrical box.
- This product is not dimmable.

SAVE THESE INSTRUCTIONS!

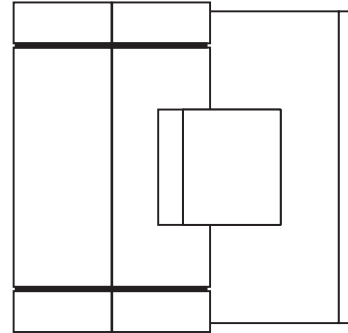

Install the Fixture

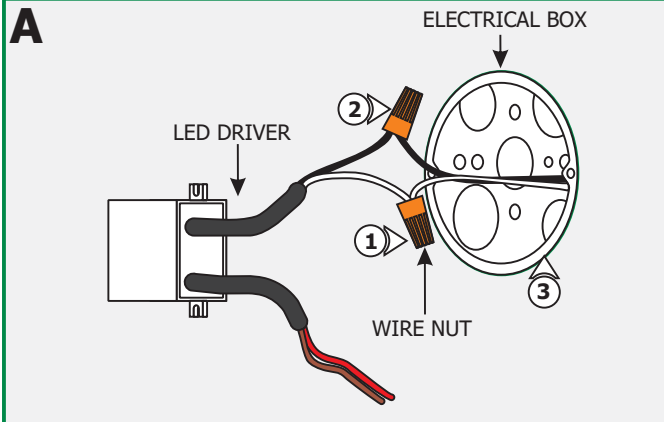

- 1:** Connect the white (NEUTRAL) LED driver wire to the neutral power wire with a wire nut.
- 2:** Connect the black (HOT) LED driver wire to the hot power wire with a wire nut.
- 3:** Place the LED driver and wire nut connections inside the electrical box.

- 4:** Mount the crossbar assembly to the electrical box holes with the provided #8-32 screws.
- 5:** Feed the brown and red LED driver wires through the crossbar assembly center hole.
- 6:** Make sure the crossbar assembly is grounded in accordance with local electrical codes.

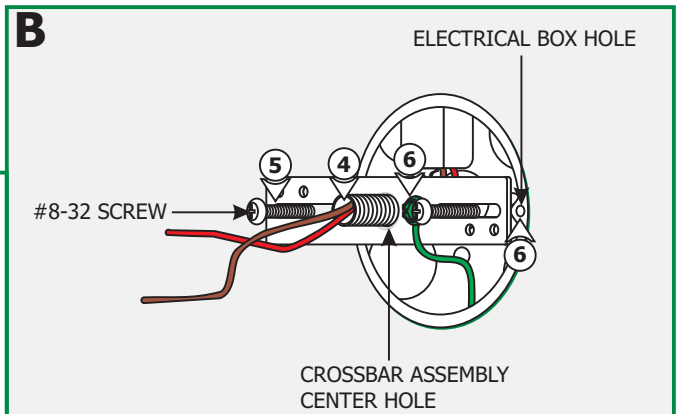

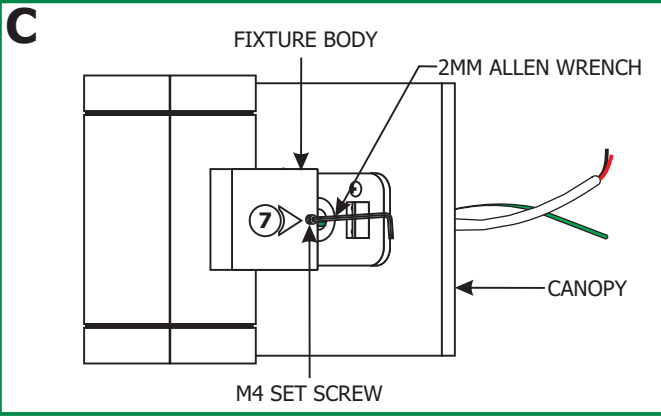

7: Loosen the two M4 set screws on the fixture body (**Do Not Remove**) with the provided 2mm Allen wrench and carefully pull the canopy off of the fixture body.

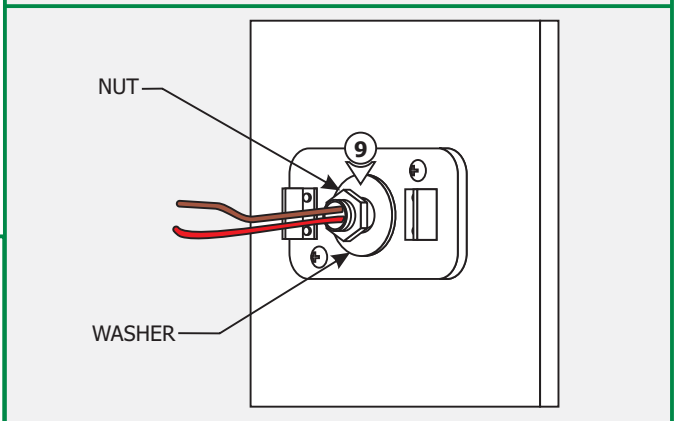
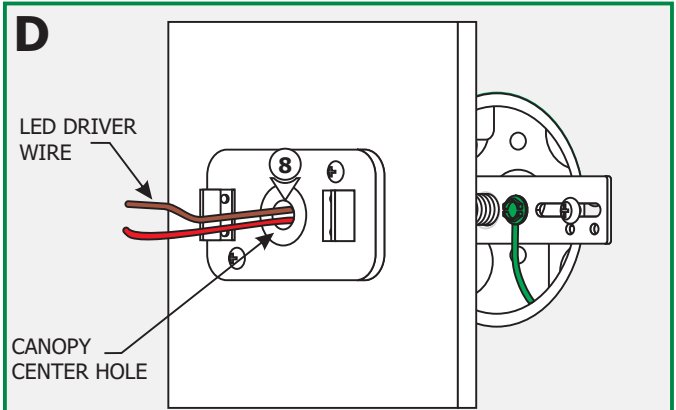

8: Feed the LED brown and red driver wires through the canopy center hole, washer, and nut provided.

9: Slide the canopy back onto the crossbar assembly nipple (make sure the gasket is in place) and secure the canopy to the crossbar assembly by tightening the nut.

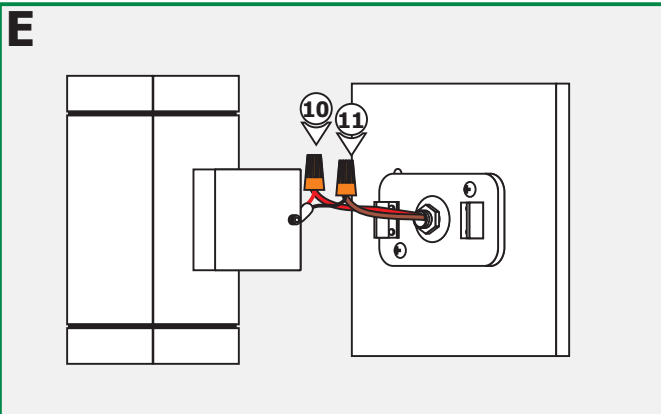

10: Connect the red fixture wire to the red LED driver wire (+) with a wire nut.

11: Connect the black fixture wire to the brown LED driver wire (-) with a wire nut.

12: Place all wires and wire nut connections inside the fixture body. Slide the fixture body completely onto the canopy and tighten the two M4 set screws with the 2mm Allen wrench.

13: For installation in **wet location**, caulk around the fixture canopy with waterproof construction sealant.

NOTE: The fixture contains two 3 watt integrated LED lamps. These lamps are rated for 40,000 hours.

