

**CIRRUS WALL WASH**

**CANDLEPOWER DISTRIBUTION**

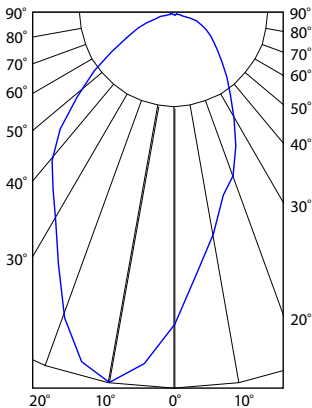

**Description:**

At 7.5 or 10 watts per foot, Cirrus Channel Wall Wash contains 85+ or 95+ CRI LEDs. Fixture mounts 24" from wall, and includes a split canopy that mounts on standard junction box. May be ordered with a Slim Profile Channel Junction Box (C-1RE-JBOX). Mounting clips are provided every 18 inches. Cirrus is powered by a Class 2 remote power supply up to 40 feet away. Available from 12 inches to 120 inches/10 feet (10DC) or to 144 inches/12 feet (7WDC). May be ordered in 3, 5, 8 or 10 inch increments. Lengths greater than 120 inches will ship as two or more segments that join together. Fixtures include a 5 year warranty.

**Finishes:**

Satin Nickel, Chrome, Antique Bronze, Satin Aluminum, White and Satin Black; Custom finishes available

**Applications:**

Wall wash, general lighting, retail and IP64 outdoor applications

**Lamp:**

Version	Watts per Foot	Lumens per Watt	Lumens per Foot	85+CRI 24K, 35K, 40K, 57K	95+CRI 27K, 30K	50,000 Hour Lamp Life
<b>7WDC</b>	7.5	37	340	●	●	●
<b>10DC</b>	10			●	●	●

Lumen values are based on the 3000K LED test.

**Power Supply (24VDC):**

- PSB-25W-010-24VDC** 120VAC input, 25 watt output
- PSB-96W-010-24VDC** 120-277VAC input, 96 watt output
- PSB-100W-ELV-24VDC** 120VAC input, 96 watt output
- PSB-2X96W-010-24VDC** 120-277VAC input, 2x96 watt output
- PSB-2X100W-ELV-24VDC** 120VAC input, 2x96 watt output

**Slim-Profile Junction Box (sold separately):**

The Slim-Profile Junction Box with hanger bars mounts to studs spaced between 14.5"- 25" apart behind drywall. Allows low voltage DC wires from remote power supply to connect to channel wires. The junction box opening is covered by the fixture for a clean, safe connection. Includes a goof plate, for poor plastering around j-box, which may be plastered and painted.

**Dimming:**

010 power supplies use 0-10V dimmer: Philips Sunrise SR1200ZTUNV. ELV power supplies use ELV dimmer: Legrand, Adorne ADTP703TU; Lutron: Diva DVELV-300P, Skylark SELV-300P, Maestro MAELV-600 and Radio Ra 2

System: **C** Channel    Size: **1RE** 1" Rectangle    Product: **JBOX** Junction Box

System: **CC** Cirrus Channel    Lens: **WW** Wall Wash    Wattage/Voltage: **7WDC** 7.5 Watt 24 Volt DC / **10DC** 10 Watt 24 Volt DC    Length in Inches: **144IN** 12-144    Color Temperature: **27K** 2700K Very Warm White    Finish: **SN** Satin Nickel    Options: **W** Wet Location (Up to 120")

PROJECT: \_\_\_\_\_ FIXTURE TYPE: \_\_\_\_\_ DATE: \_\_\_\_\_



# CIRRUS CHANNEL WALL WASH 24VDC SYSTEM, 85+ OR 95+CRI

REV10.29.14

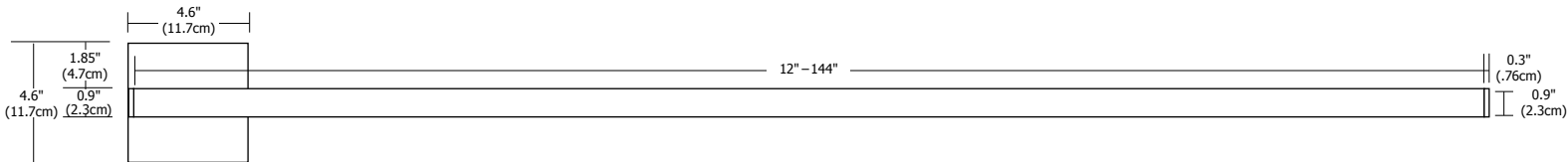

Split Canopy (included)  
with Cirrus Channel.  
May be mounted at End.

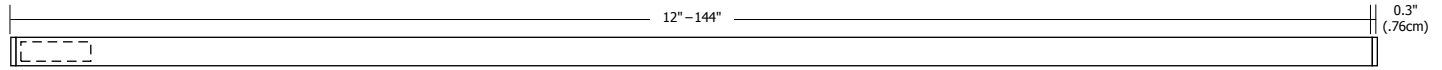

Shown with C-1RE-JBOX (sold separately)



Satin Aluminum Anodized



Satin Nickel Anodized



Antique Bronze Anodized



Satin Black Anodized



Chrome Plated



White Powder Coated

**Application:** 0-10V dimming for Cirrus Channel Wall Wash

**Power Supply:** Class 2, 24VDC output: 120VAC input, PSB-25W-010-24VDC;  
120-277VAC input, PSB-96W-010-24VDC; PSB-2X96W-010-24VDC

**Dimming:** Dimmable with 0-10V dimmer: Philips Sunrise SR1200ZTUNV, 0-10V dimmer recommended

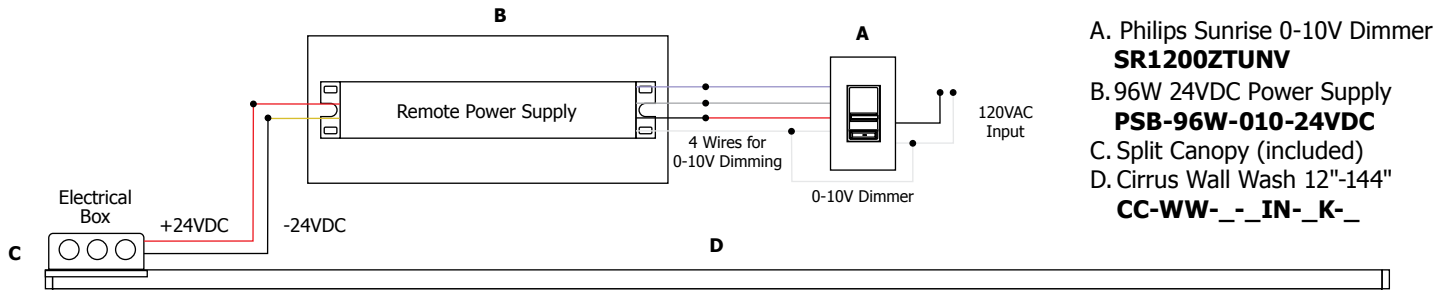

Fixture Mounted 24 inches from wall

1'	14	14	14	14	14	14
2'	25	25	25	25	25	25
3'	28	28	28	28	28	28
4'	22	22	22	22	22	22
5'	15	15	15	15	15	15
6'	11	11	11	11	11	11
7'	9	9	9	9	9	9
8'	5	5	5	5	5	5

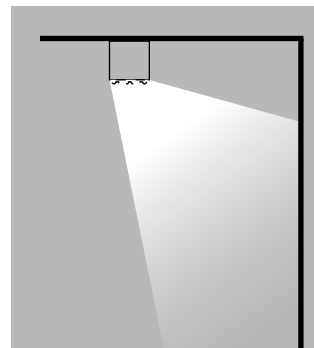

PROJECT:

FIXTURE  
TYPE:

DATE:

# SLIM-PROFILE JUNCTION BOX

REV09.04.14

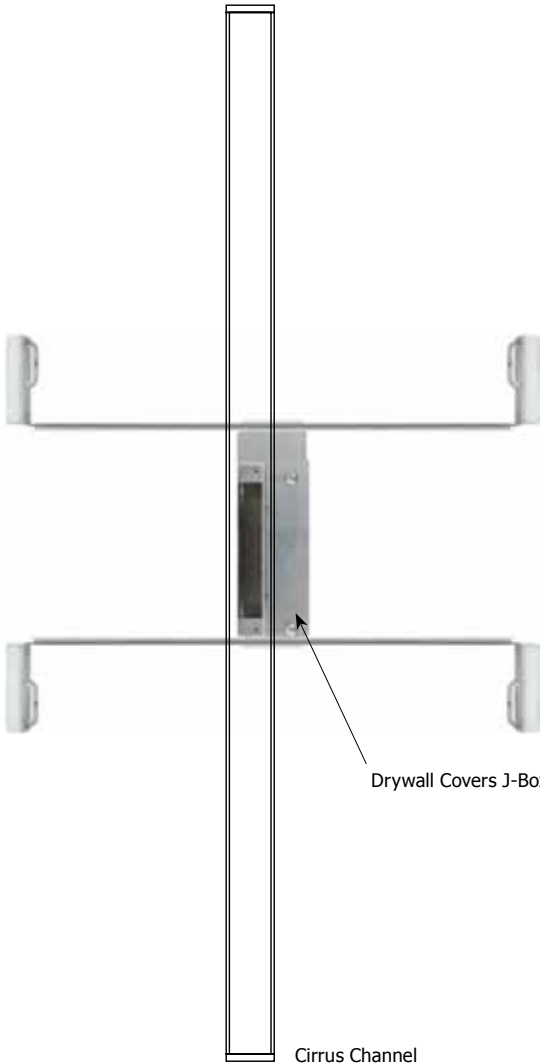
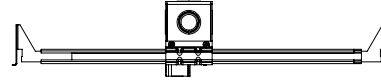
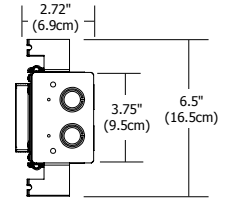
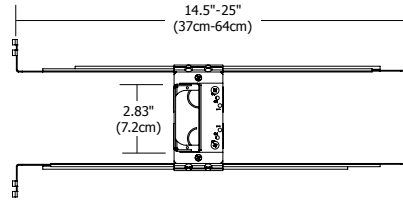

## Description:

The Slim-Profile Junction Box with hanger bars mounts to studs spaced between 14.5"- 25" apart behind drywall. Allows low voltage DC wires from remote power supply to connect to channel wires. The junction box opening is covered by the fixture for a clean, safe connection. Includes a goof plate, for poor plastering around j-box, which may be plastered and painted.

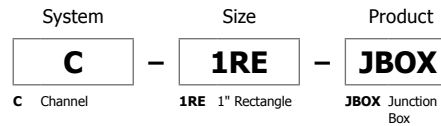

PROJECT:

FIXTURE  
TYPE:

DATE:

# CHANNEL L-SHIELD FOR CIRRUS WALL WASH AND WALL GRAZER

REV10.29.14



## Description:

The Channel L-Shield mounts to the ceiling along the Cirrus Wall Wash or Cirrus Wall Grazer fixtures (with C-1RE-JBOX only) to shield light brightness from view.

System	Product	Length	Finish
<b>C</b>	<b>L2.5</b>	<b>8FT</b>	<b>WH</b>
C Channel	L2.5 L- Shield 2.5" Height	8FT 8 Feet	WH White

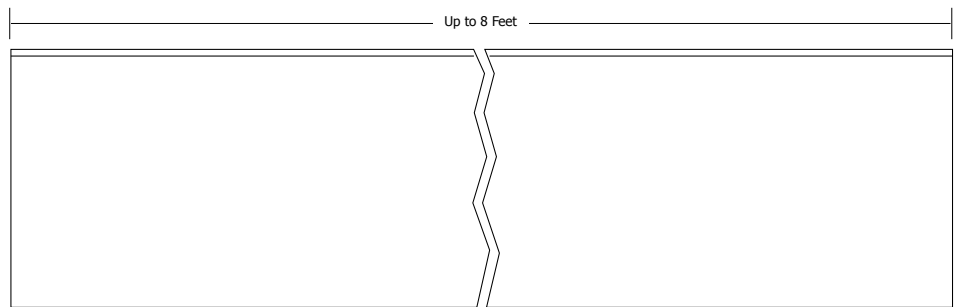
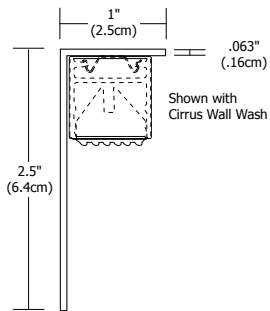

PROJECT:

FIXTURE  
TYPE:

DATE:

Please refer to chart below for exact lengths of the Cirrus Channel Wall Wash

CODE	LENGTH (INCHES)
12IN	12.8
15IN	15.2
17IN	17.6
20IN	20
22IN	22.4
24IN	24.8
27IN	27.2
29IN	29.6
32IN	32
34IN	34.4
36IN	36.8
39IN	39.2
41IN	41.6
44IN	44
46IN	46.4
48IN	48.8
51IN	51.2
53IN	53.6
56IN	56
58IN	58.4
60IN	60.8
63IN	63.2
65IN	65.6
68IN	68
70IN	70.4
72IN	72.8
75IN	75.2
77IN	77.6

CODE	LENGTH (INCHES)
80IN	80
82IN	82.4
84IN	84.8
87IN	87.2
89IN	89.6
92IN	92
94IN	94.4
96IN	96.8
99IN	99.2
101IN	101.6
104IN	104
106IN	106.4
108IN	108.8
111IN	111.2
113IN	113.6
116IN	116
118IN	118.4
120IN	120.8
123IN	123.2
125IN	125.6
128IN	128
130IN	130.4
132IN	132.8
135IN	135.2
137IN	137.6
140IN	140
142IN	142.4
144IN	144.8

PROJECT:

FIXTURE  
TYPE:

DATE: