

PUCK LED 3W, 12V AC/DC



Surface Mount - White

Surface Mount - Satin Aluminum

Surface Mount (Collar Included)

Recessed

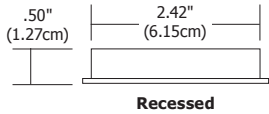

Recessed

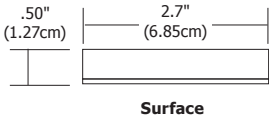

Surface

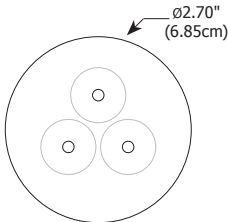

Description:

Recessed or surface-mount, Puck **LED** features solid aluminum construction and uses only 3 watts of warm-white **LED** light. Ideal for under cabinet illumination. The tiny but very powerful round fixture is available with a 90 degree beam spread. Includes 36" cord/plug port, wire clips and screws. Fixture plugs into 4- or 8-port hub, which distributes the low voltage power from **LED** power source. Fixtures use 12VAC or 12VDC power supplies and include a 5 year warranty.

Finish:

Satin Aluminum or White

Lamp Specification:

4 Total Watts, 138 total lumens, 12V AC or DC **LED**, 3070K, 84CRI, 70% lumen maintenance based on 50,000 hours of operation

Dimming Information:

Dimmable with Lutron Diva or Skylark standard electronic low voltage dimmers. AC power supplies dim down to 20% before flickering and slight buzzing

Power Supply:

Hardwired: **TE-60L-12**

Plug-In: **TE-60L-12AC-P**

Weight:

.5 lb (0.23 kg)

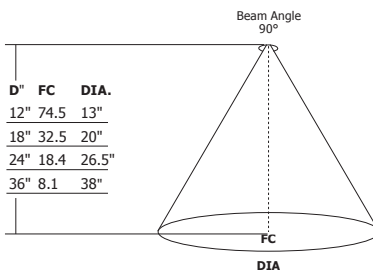
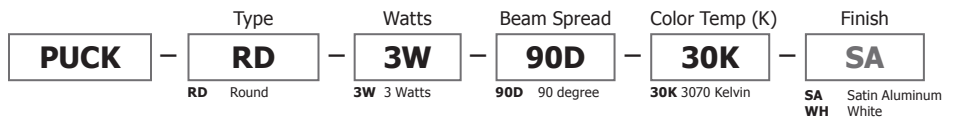

PROJECT:

FIXTURE TYPE:

DATE:

POWER HUB FOR PUCKS & DOTS

REV.04.20.12

8 Port Hub shown

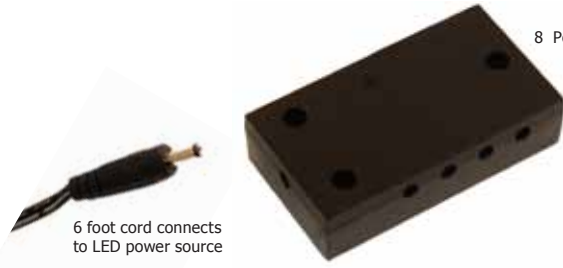

6 foot cord connects to LED power source

Description:

The 4 or 8 Port Hub distributes the 12V AC/DC low voltage power from LED transformer to a combination of 1 to 4 or 1 to 8 LED Puck or Dot lights. Includes 6 foot Power Feed Connector Cord and 3 clips.

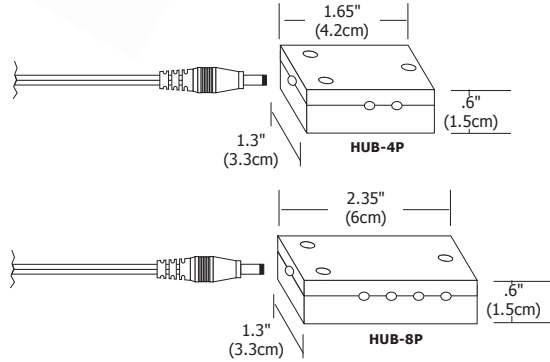

Product	Type
HUB	4P
HUB Power Hub	4P 4 Port 8P 8 Port



12 Ft. Hub Extension Cord and Hub Connector

The 12 ft extension cord extends the Hub power cord or the Puck and Dot fixture cord. Includes 6 pieces of WC-1 wire clips. Use HUB-HUB-12 to link multiple Hubs together.

Product	Type	Length
HUB	EC	12
HUB Power Hub	EC Extension Cord HUB Hub to Hub	12 12 Feet



Wire Clips

Wire Clips keep wires organized. Secure with screws or double-sided tape (included). 3 wire clips provided for each fixture. Also sold separately.

Product	Type
WC	1
WC Wire Clip	1 Standard

PROJECT:

FIXTURE TYPE:

DATE:



Electronic 60 Watt AC Transformer with Rectangle Canopy Cover

TE-60L-12 Electronic 60 Watt 12 Volt AC hard wire fits inside single gang electrical box covered with a white 3" rectangular canopy, powering the Dots and Pucks.

Product	Wattage	Voltage	Type	Finish
TE	60L	12AC	3RE	WH
TE Transformer Electronic	60L 60 Watt LED	12AC 12 Volt AC	3RE 3 Inch Rectangle Canopy Cover	WH White



Electronic 60 Watt LED AC Transformer Plug-In

Plug-In version of the TE-60L-12 Electronic 60 Watt 12 Volt AC Transformer includes 10 ft of cord and DC Connector to plug into the HUB-4P or HUB-8P powering the Dots and Pucks.

Product	Wattage	Voltage	Type
TE	60L	12AC	P
TE Transformer Electronic	60L 60 Watt LED	12AC 12 Volt AC	P Plug In



Electronic 60 Watt LED AC Transformer

TE-60L-12 Electronic 60 Watt 12 Volt AC Transformer converts standard 120 volt line voltage to 12 volts and features built-in short-circuit protection. Fits inside an electrical junction box. Minimum dimming load is 6 watts.

Product	Wattage	Voltage
TE	60L	12
TE Transformer Electronic	60L 60 Watt LED and Halogen	12 12 Volt AC



3" Rectangle and 4" Round Canopy Cover

The white rectangle or round canopy cover conceals the TE-60L-12 LED transformer (sold separately) inside a single gang box to power Dots and Pucks.

Product	Finish
3RE	WH
3RE 3 Inch Rectangle Canopy Cover	WH White
4RD 4 Inch Round Canopy Cover	

PROJECT:

FIXTURE TYPE:

DATE:

Application: Electronic low-voltage dimming for 4 Puck LED fixtures

Power Supply: 60 watt, 120 volt input, 12 volt AC output **TE-60L-12**

Dimming: Dimmable with Lutron Diva #DVELV-300P or Skylark #SELV-300P standard electronic low voltage dimmers. AC power supplies dim down to 20% before flickering and slight buzzing

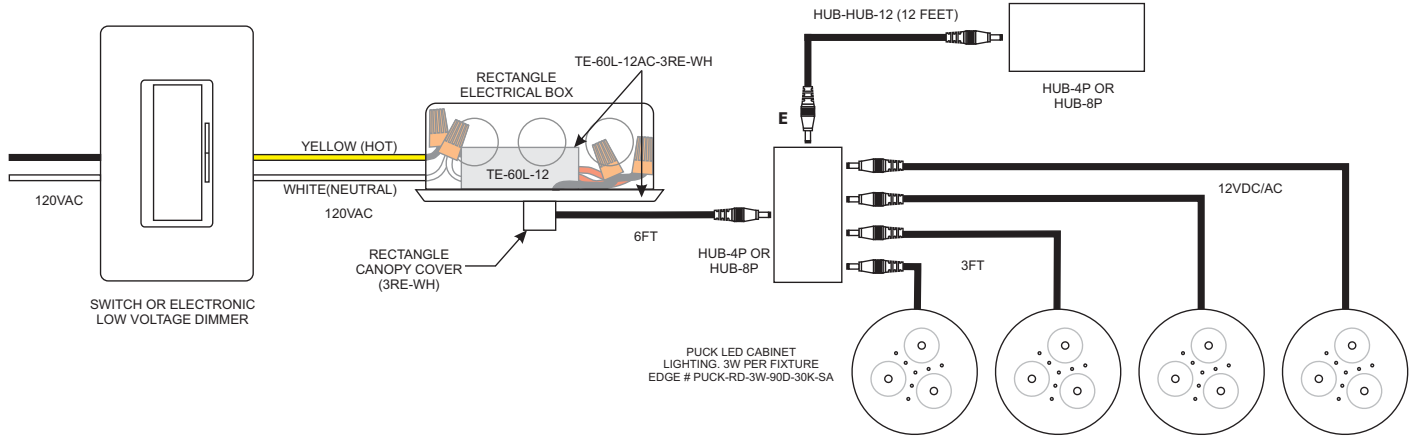

PROJECT:

FIXTURE TYPE:

DATE:

Application: Electronic low-voltage dimming for 7 Puck LED fixtures

Power Supply: 60 watt, 120 volt input, 12 volt AC output **TE-60L-12AC-P**

Dimming: Dimmable with Lutron Diva #DVELV-300P or Skylark #SELV-300P standard electronic low voltage dimmers. AC power supplies dim down to 20% before flickering and slight buzzing
See power supply spec sheet for additional details.

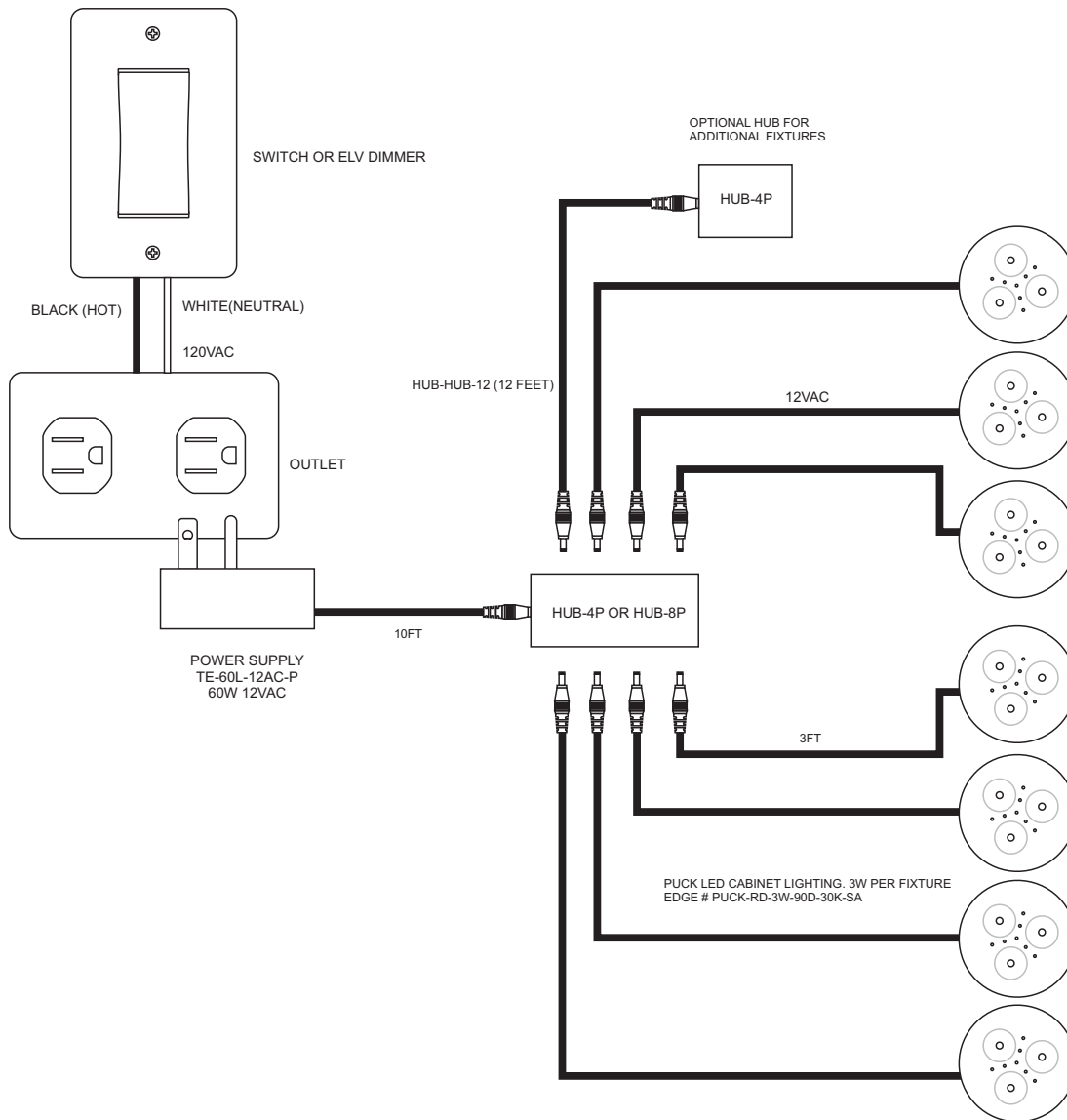

PROJECT:

FIXTURE TYPE:

DATE: