



**GENERAL PRODUCT INFORMATION:**



This product is suitable for damp locations.

This product can mount either to a 4" square electrical box with a round plaster ring or an octagon electrical box.

This product may be mounted horizontally or vertically.

This instruction shows a typical installation.



**CAUTION — RISK OF FIRE**

This product requires installation by a qualified electrician. Before installing be sure to read all instructions and DISCONNECT POWER TO THE ELECTRICAL BOX.

**NOTE:** Due to the weight of this fixture, assistance will be needed for installation.

**Install the Fixture**

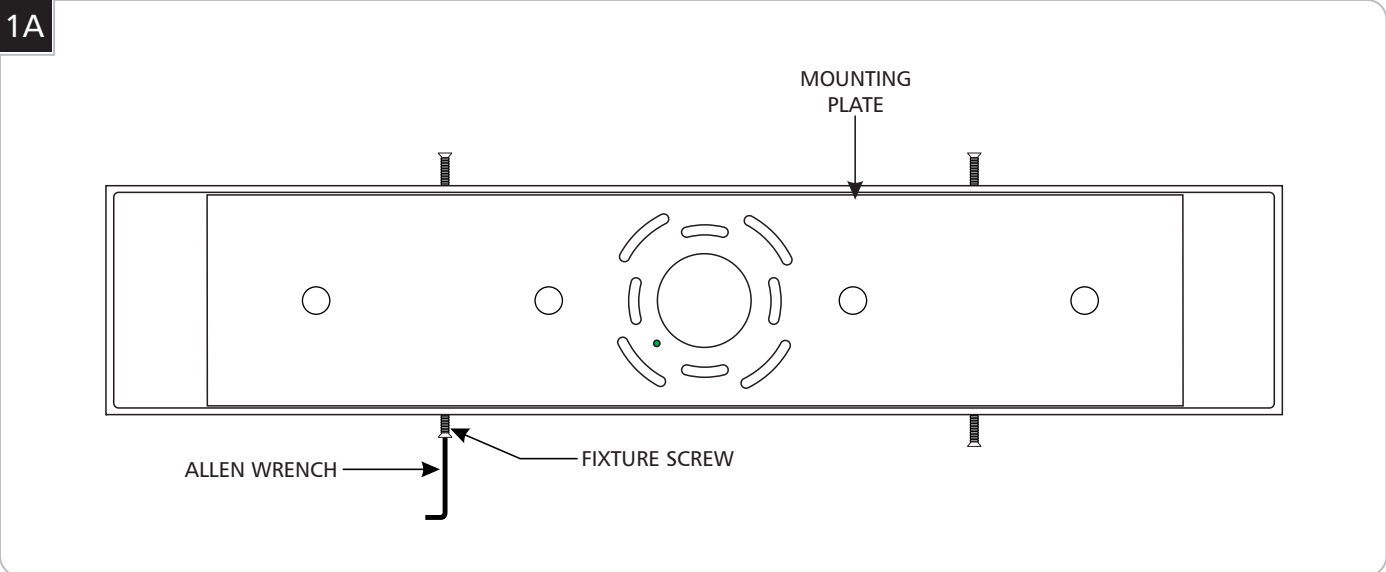

- 1** With the Allen wrench provided, unscrew and remove the four fixture screws.
- 2** Separate the mounting plate from the fixture.

1B

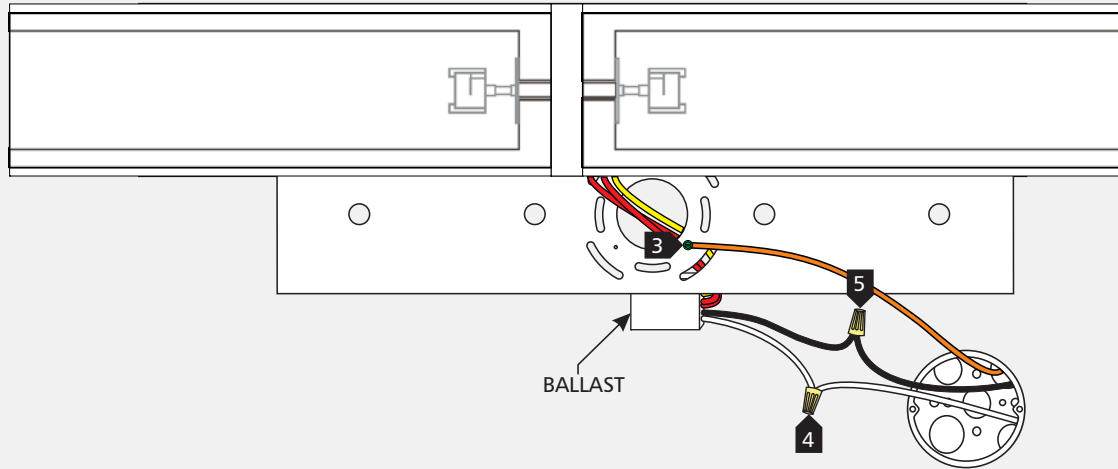

- 3 Connect the mounting plate ground wire to a suitable ground according to local electrical codes.
- 4 Connect the white ballast wire to the neutral power line wire with a wire nut.
- 5 Connect the black ballast wire to the hot power line wire with a wire nut.

1C

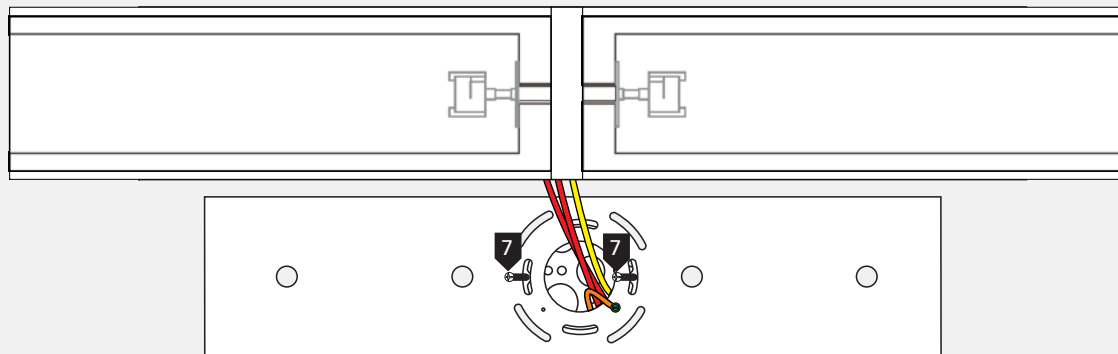

- 6 Properly place all wires, wire nut connections, and the ballast inside the electrical box.
- 7 Level the mounting plate and secure it to the electrical box with the two #8-32 screws provided.

1D

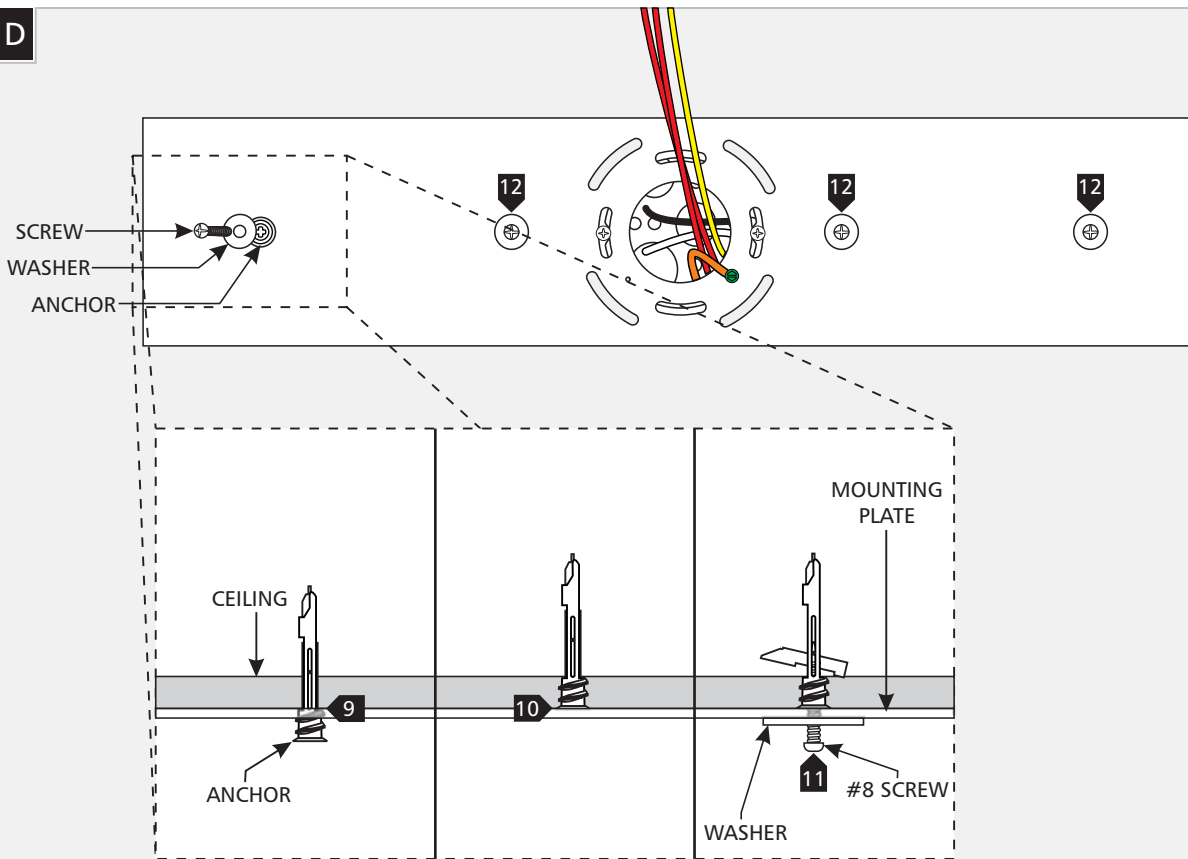

- 8 Verify that the mounting plate is level before continuing.
- 9 Line an anchor tip with the center of an anchor hole and hammer the anchor into the wall up to the threaded portion.
- 10 Screw the anchor in the rest of the way with a Phillips-head screwdriver.
- 11 Slide a #8 screw through a washer and screw it into the anchor to secure the mounting plate to the wall.
- 12 Repeat for the other anchor holes.

1E

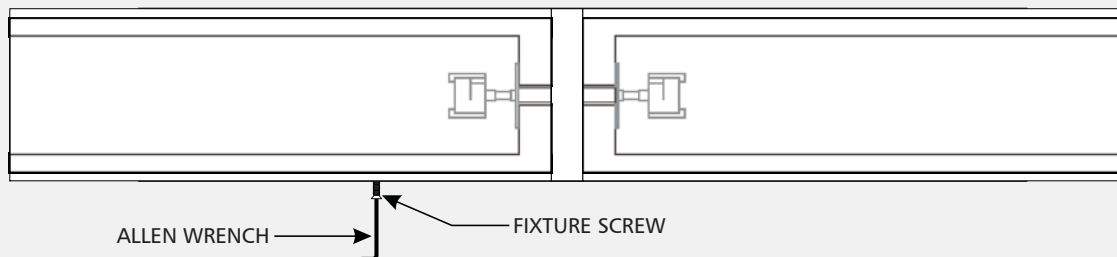

- 13 Re-place the fixture onto the backplate and re-install the fixture screws.
- 14 Secure the fixture onto the mounting plate by tightening the fixture screws with the provided allen wrench.

# Install the Lamp and Diffuser

2A

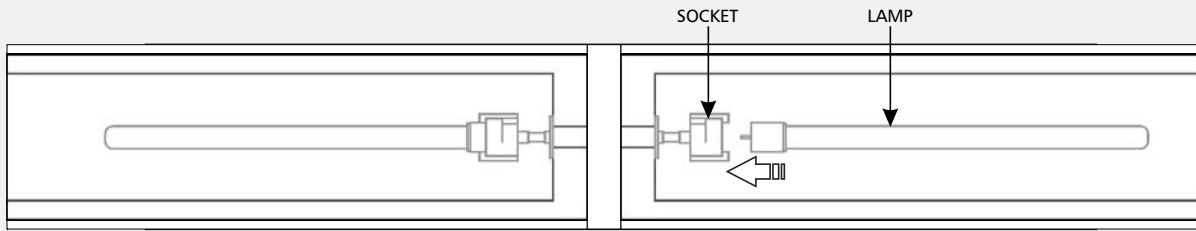

**CAUTION:** To reduce the risk of a burn or electric shock during relamping, disconnect the power to the fixture.

Use MAX 18 Watt Type T5  
Twin Tube, 2G11 Base Compact Fluorescent Lamp.



1 Push the lamp base into the socket.

2B

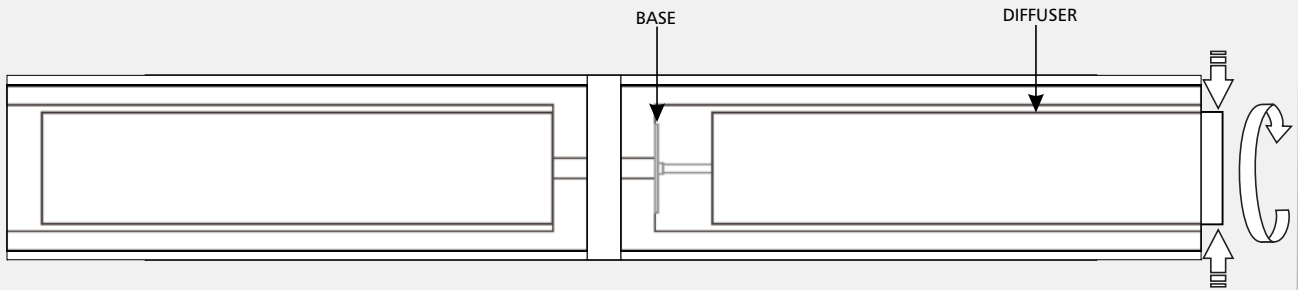

**CAUTION:** When installing the diffuser, apply even pressure on each side of the diffuser by using both hands to screw it in place. **DO NOT OVER TIGHTEN** the diffuser. This may break the glass resulting in injury.

**NOTE:** It is not necessary to remove the diffuser when replacing the lamp. If necessary, the diffuser may be removed to clean inside the outer glass.

2 Gently screw the diffuser onto it's base .

**SAVE THESE INSTRUCTIONS!**



**TECH LIGHTING®**

7400 Linder Ave, Skokie, IL 60077

847.410.4400

[www.techlighting.com](http://www.techlighting.com)

© 2012 Tech Lighting, L.L.C. All rights reserved. The "Tech Lighting" graphic is a registered trademark of Tech Lighting, L.L.C. Tech Lighting reserves the right to change specifications for product improvements without notification.

A Generation Brands Company